

110 AMAZING MAGIC TRICKS With Everyday Objects



110 Amazing Magic Tricks With Everyday Objects

Compiled and Edited by Marvin Berglas,
Marvin's Magic

Copyright by Marvin's Magic, 2002

All rights reserved

Published by Marvin's Magic, 3 London Road, Herts AL3 8JL



Magic is a wonderful hobby.

We have selected 110 superb magic tricks, most of which can be performed with simple everyday objects. Once learned, you will be able to mystify and entertain no matter where you are. Read and follow the illustrated instructions carefully and regularly practice and rehearse the tricks until you feel completely confident - then get ready to baffle, bewilder and amaze! But remember our magicians code and NEVER REVEAL YOUR SECRETS! Have Fun!

Magically Yours

A handwritten signature in black ink that reads "Marvin Berglas". The signature is written in a fluid, cursive style.

Marvin Berglas - Marvin's Magic



Cup Through Table

Effect: A cup or glass vanishes when wrapped in a sheet of paper.

Secret: A piece of paper wrapped around the cup or glass will retain the shape of the cup – even after the magician has secretly dropped the cup into his lap.

Props: A cup or glass, any small object and a sheet of newspaper or tissue paper.

Preparation: Select a piece of newspaper slightly larger than the cup so that it will cover it completely with some overlap.

Presentation: Place the cup over any small object and wrap the paper around it. Ask the audience what is under the cup. Everyone will, of course, suspect that you are about to vanish the object. Lift the paper and cup to reassure everyone that the object is still on the table. Moving the wrapped cup slightly towards you, just clear of the table relax your hold so that the cup is allowed to quietly drop into your lap, out of sight of the audience, of course, whose attention is still focused on the object. The paper will retain the shape of the cup. When you again place the paper over the object, you must maintain the illusion that you are replacing both paper and cup. Wave your hand mysteriously over the "cup" and claim that you will make the object vanish. When you lift the "cup" the object is still there. Remove the object but replace the "cup". Tell the audience that something must have gone wrong and you are unable to vanish the object, so you have decided to vanish the cup instead! At that moment dramatically smash your hand down onto the paper which will flatten, giving the appearance that the "cup" has penetrated the table. Bring the cup from under the table (removing it from your lap, in one smooth movement) and replace it on the table.

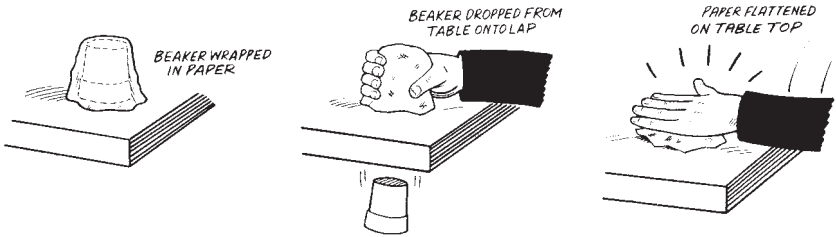

Wand Power

Effect: The magician makes some mysterious passes around a wand or pencil which uncannily starts to move on its own.

Secret: The magician secretly blows on the wand, which causes it to roll.

Props: Use a wand or pencil. A smooth, firm surface is essential.

Preparation: Practise blowing toward the wand gently and secretly.

Presentation: Lay the wand on the table and very slowly trace circles around the outside of the wand with a finger. Then, as you move the finger away, the wand seems to follow. You claim to have created a static field that pulls plastic like a magnet. The trick is that as you draw the finger away from you and from the wand, you blow gently on the wand. The audience is so busy watching the movement of the finger, they won't notice that you are blowing towards the wand, which causes it to roll easily on the flat surface.

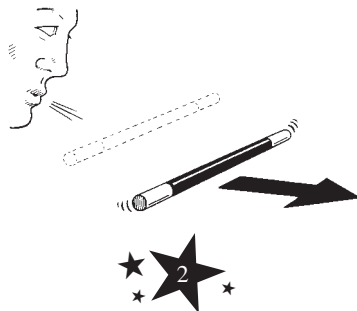

Ring And String

Effect: A ring threaded onto a loop is released, although a spectator is holding the string.

Secret: Read PREPARATION carefully to see how you can solve this puzzle.

Props: Any ring and one cord.

Preparation: Get someone to help you practise this item before presenting it. Tie one piece of cord into a loop (circle). Slide the ring onto one end of the loop. Have your friend hold up his fingers. Put each end of the loop over one finger (see figure 1) but not too tight. Take a section of this cord and make another loop over the finger on the other side of the ring (see figure 2). Be sure you put the second loop below the first loop on the finger. Take the original loop and carefully lift it above the finger (see figure 3). Tell the holder to tighten up on the cord. As he does, you let go of your loop. The ring will fall free even though the string is still on his fingers. You will have to practise this a number of times before you can expect to do it smoothly.

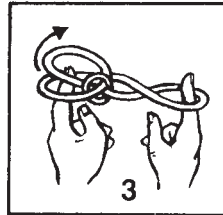
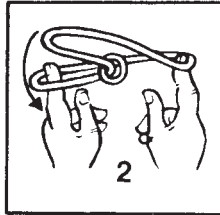
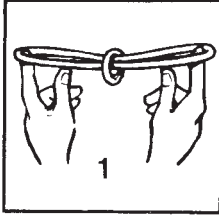

Appearing Wand

Effect: From a small purse you produce a large solid magic wand or pencil.

Secret: Obtain a small money purse and cut a small hole at the bottom.

Presentation: Have the wand partly up your sleeve and the other end inside the purse, through the hole. Show the purse, then open it and slowly pull out the large wand. This impressive illusion should be practised in front of a mirror. It is a real fooler and worth the extra trouble in obtaining a suitable purse.

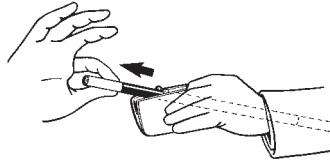

Rubber Wand

Effect: The magician's solid wand or pencil seems to turn to soft rubber. On command, it turns solid again.

Secret: Hold the wand horizontally in front of you between thumb and forefinger about a third of the way from the end. By moving your hand up and down in short quick moves, the wand will seem to become flexible and appear as if it were made of rubber (see illustration). This is an excellent optical illusion.

Presentation: Tap the wand on something to show that it is solid. Say the magic word and now demonstrate that it is wobbly and flexible. Another magic word and it turns solid again.

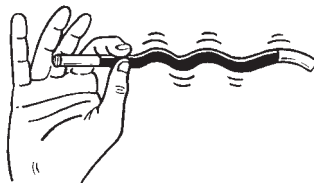

Palm The Wand

Effect: To prove that you have magical powers, place the wand or pencil across the top of the palm of one hand, with the back of the hand towards the audience. Slowly open your fingers and the wand apparently sticks to the hand as if magnetised (see figure 1).

Secret: Grip your wrist with your other hand (see figure 2). Unbeknown to your audience, your right index finger is holding the wand. Don't ever let the audience see the way you hold the wand.

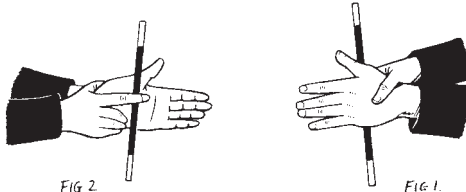

FIG 2

FIG 1

Find The Coin

Effect: A coin is covered with any one of three cups and the cups are then moved around. You can say immediately which cup is covering the coin.

Secret: Attached to the coin is a long hair. When the coin has been covered the three cups can be moved around as much as anyone wants. Although your back has been turned while this has been going on you can easily locate which cup hides the coin. All you have to do is look for the hair sticking out from beneath one of the cups and that tells you all you need to know!

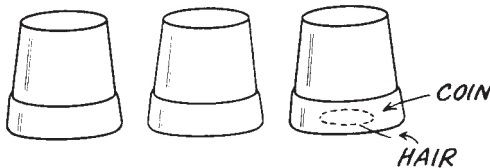

Reverse Loops

Effect: A cord, coiled around a magic wand or pencil and tied through a ring, is pulled free of the wand and yet the ring remains securely tied.

Secret: As you wind on the cord, you secretly reverse the direction.

Props: A magic wand or pencil, a ring and a length of cord.

Preparation: Practise coiling the cord around the wand until you can do it without hesitation.

Presentation: Take the cord and wind it around the magic wand in one direction for the loops then stop as if counting the loops with the first finger of the hand that is holding the wand. Leave the tip of the finger on the wand, just past the third loop (see illustration). Then add three more loops but in the reverse direction.

Practise this carefully and try to get the ends of the cords to hang down about the same lengths. Cover all of the loops with your free hand, now have someone tie a ring to the two loose ends of the cord. As you say a magic word, have him pull straight down and the cord will come free from the wand.

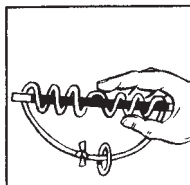

Sticky Wand

Effect: This effect is similar to "Palm the Wand" but takes a little more practice to do it correctly.

Secret: A combination of holding the wand or pencil in different ways will give the impression that it has become magnetised and is sticking to your fingers magically.

Presentation: Hold the wand between your hands (see figure 1). Lift one thumb (see figure 2).

The audience will still think that your other thumb is holding the wand. Then lift the second thumb (see figure 3). They will be amazed! Study figures 4 and 5 and you will see how the trick is achieved. Carefully interlace your fingers so that one is folded inside your palms (see figure 4). The wand is held behind this hidden finger (see figure 4). Pull your hands apart quickly and let the wand fall when the trick is over.

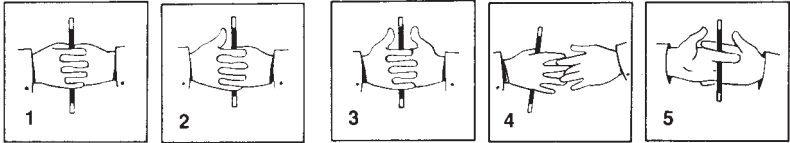

Rising Pencil

Effect: The magician places a pencil into a bottle. It reacts to his commands and slowly rises and falls in the bottle.

Secret: The pencil is made to move with the aid of a very fine thread.

Props: A pencil, a vase or bottle and a fine thread.

Preparation: A very fine nylon or black cotton thread or even a long human hair (18 inches to 24 inches in length) is tied, taped or applied with wax to one end of the pencil. The other end is tied to a button on the magician's clothing.

Presentation: Drop the pencil (thread end first) into the bottle or vase (see illustration). By moving slightly away from the table the thread will become tight and, on command, the pencil will either rise or fall, depending on your movements.

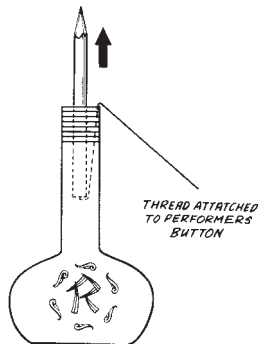

Dice Deception

Effect: You read someone's mind.

Secret: Whilst your back is turned (or you can be blindfolded) someone throws a die on the table. Ask him to remember the number thrown and then to make another throw. Tell him to double the first number he threw and to add five to the answer. He has now to multiply his answer by five and then add on the second number thrown. Ask him what total he has reached. Mentally subtract 25 from the answer he gives.

You will end up with a two digit number – the first digit is the first number thrown and the second is the second number thrown. Now pretend to read the spectator's mind and tell him what numbers he threw.



Bewildering Beaker

Effect: A beaker vanishes.

Secret: The beaker is glued to a small wooden tray. In the centre of a scarf sew a circle of cardboard. Show the beaker then cover it with the scarf or handkerchief. Lift the scarf (holding the cardboard disc so it looks as if you are holding the rim of the beaker) and turn the tray towards you. Stand the tray against something on your table – with the beaker side away from the audience. Everyone believes you are holding the beaker. Throw the scarf in the air and catch it as it falls – the beaker has vanished.

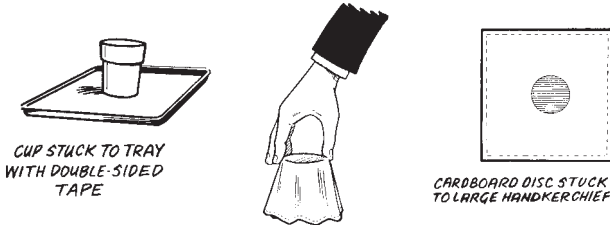

Ring On

Effect: A ring is magically threaded on a string.

Secret: Place the string and ring supplied on a table, together with a safety pin and a handkerchief. Cover the string, ring and pin with the handkerchief. Allow the ends of the string to remain visible at all times. Place your hands beneath the handkerchief and push the centre of the string through the ring. Open the pin then close it so it goes around the right side of the loop and the rest of the string (see figure 1). Put your left forefinger into the loop (see figure 2). Remove your right hand and lift up the right end of the string and ask someone to hold it. At the same time move your left hand along the string (keeping your finger in the loop) until you reach the end. Remove the handkerchief and show that the ring and pin are now on the string (see figure 3).

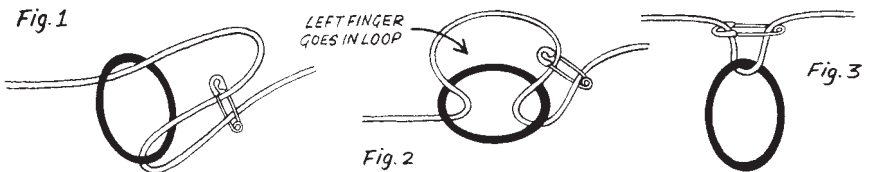

Floating Beaker

Effect: A plastic beaker floats in the air.

Secret: On one side of a plastic beaker attach a strip of strong paper. It is important that the paper is loose along the centre portion. To make the beaker appear to float, you push your right thumb through the paper loop. Place your left hand near your right hand and then lift your hands in the air. With practice it will appear that the beaker is floating in the air. Keep the taped side of the beaker nearest your body so the audience do not see it.

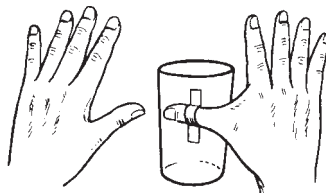

The Removable Thumb

Effect: You appear to remove your thumb!

Secret: Practise this in front of a mirror. Hold out your left hand with the palm facing you. Bend your left thumb in half towards your body. Bend your right thumb in half and place it alongside the left (see figure 1). Place your right forefinger over the front of the two thumbs where they touch (see figure 2). Move your right hand to the right and it looks as if you have removed your thumb (see figure 3). This trick should be done only to people who are directly facing you.

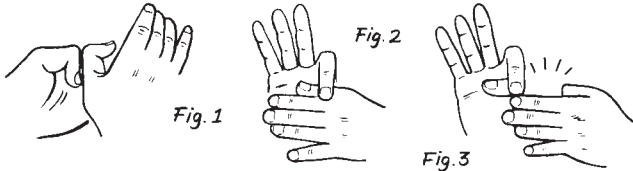

Folding Money

Effect: A currency note turns itself over.

Secret: Hold the note in your left hand then fold it in half lengthways towards you. Next fold it in half again from you. Finally, fold the note in half again, this time towards your body. Now slowly unfold the note from the front, making each movement in the same direction. The note is now upside down! Strangely enough, this trick is more baffling if you do it really slowly but, like all tricks, you must practise it thoroughly to make sure you can do it perfectly before showing it to anyone.

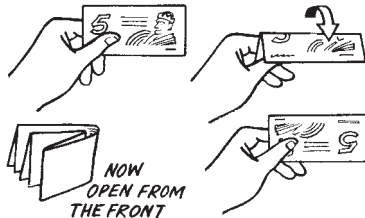

Stop!

Effect: A matchbox obeys your commands.

Secret: Run a thread through the end of a matchbox drawer (see figure 1). Put a small eraser or a block of wood in the drawer on top of the thread (see figure 2) then close the box. You are now ready to show the trick. Hold each end of the thread, with one hand above the other. The matchbox should be near the top of the thread. If you hold the thread loosely the box will slide down the thread but if you secretly tighten the thread the box will stop (see figure 3). With practice you can make it stop or go at your command.

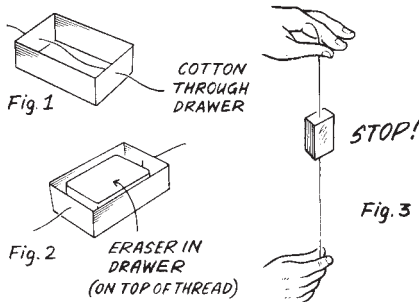

Kings And Aces

Effect: Two playing cards make a mysterious journey.

Secret: You need a special playing card. First glue an Ace of Spades and a King of Diamonds back to back. Cut an Ace of Clubs in half lengthways. Glue this on top of the Ace of Spades. Now glue a smaller strip of another King of Diamonds on top of that. Hold a King of Hearts against the special card and it looks like four cards. Place the four cards in a box. Bring out the King of Hearts and place it in another box. Secretly turn the special card over and bring it out, showing the King of Diamonds. Also place this in the other box. Show the first box empty. The Aces have vanished. Take all four cards (really only two) from the second box, showing them as you did before. It seems that the Aces have magically travelled across.

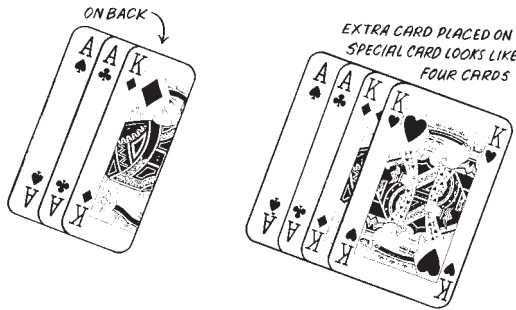

Spelling Bee

Effect: Ten cards are counted in a magical manner.

Secret: The cards you use have been secretly arranged in the order shown. The actual suits do not matter. Run the cards, one at a time, from hand to hand. This reverses the order so the Nine is now on the top. Place the 10 cards on the pack. To show the trick count off 10 cards (this gets the arrangement back to normal, with the Three on top). Take the cards one at a time from the top of the packet and place them on the bottom as you spell A C E (one card to each letter). Turn over the card on the E and it is an Ace. Drop this card on the table. Now spell T W O – again moving one card from the top to the bottom of the packet for each letter. Turn over the "O" card, a Two, and drop it on the table. Continue spelling in this way until you get to 10. For the 10th card you have only one card left but pretend to spell the letters as before to amuse your audience.

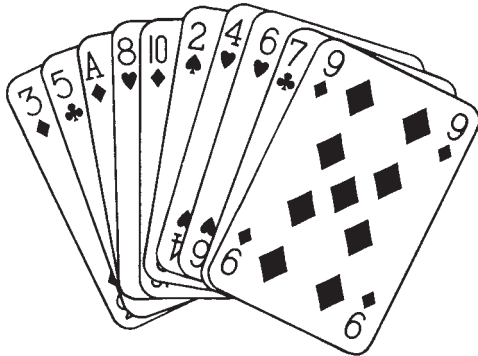

A Neat Escape

Effect: You escape from a rope.

Secret: Ask someone to tie your wrists together with a large scarf. A long length of soft rope is now placed between your wrists and someone holds the ends. Another scarf is thrown over your bound wrists. As soon as your hands are out of sight move your hands back and forth to cause the rope to form a loop between your wrists. Keep working the rope until you can get one hand into the loop. When you have done this ask the person who is holding the rope to pull – the rope will come free and yet your wrists are still tied!

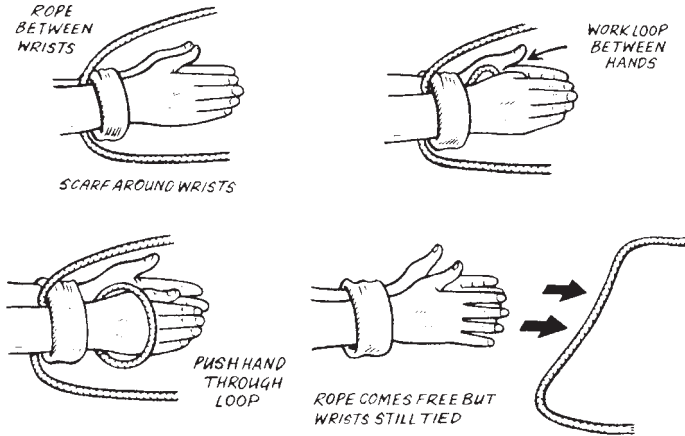

Pencil Vanish

Effect: A pencil disappears.

Secret: Show a pencil or pen and drape a large handkerchief over it. As soon as the pencil is out of sight, secretly extend your forefinger under the handkerchief as you allow the pencil to drop down your sleeve. Take the handkerchief with the other hand as if holding the pencil through the material. Throw the handkerchief into the air and the pencil has vanished!

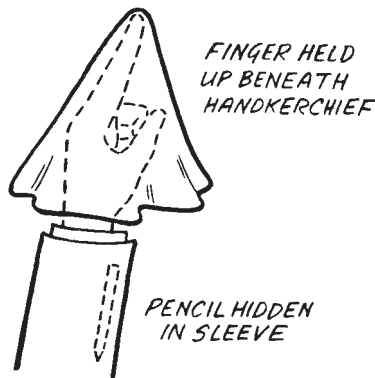

Knot From Nowhere

Effect: A knot mysteriously appears in the corner of a handkerchief.

Secret: Before your performance, secretly tie a knot in one corner of a handkerchief. Show the handkerchief but hold it with the knot hidden in your right hand. The left hand now lifts the bottom end of the handkerchief and places it in the right hand along with the top corner. Give the handkerchief a shake and drop the unknotted end. Repeat this two or three times. On the second or third attempt allow the knotted corner to drop, retaining your grip on the other corner. All you have done is change the corner you are holding but it appears that the knot has formed by magic.

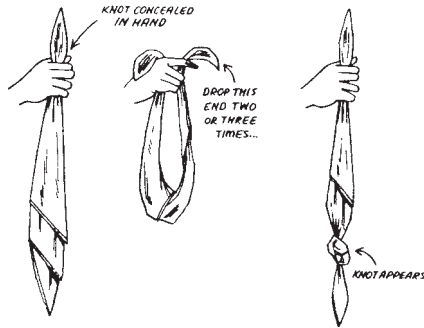

Card To Matchbox

Effect: A playing card changes into a matchbox.

Secret: Trim a playing card and glue it to the top of a matchbox. Carefully fold the card over the box as shown. Glue a matchbox label on the back of the card so when the card is folded it looks like an ordinary matchbox. Show your audience the playing card. The matchbox is hidden behind it. Bring your hand over the card and secretly fold it up over the box. Remove your hand and it seems that you have made a playing card change magically into a matchbox.

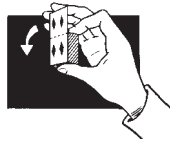

It's Matchic!

Effect: You reveal how many matches were moved while your back was turned.

Secret: Secretly put a small pencil dot on a match, just below the head. Do this on all four sides of the match and then put it back in the box. When you show the trick, remove ten matches from the box and put them down in a row. The marked match must be placed at the left end of the row. Turn your back and ask someone to move any number of matches, one at a time, from the left end of the row to the right. When you turn around you have only to spot the position of the marked match and count from that to the right end of the row to know how many have been moved.

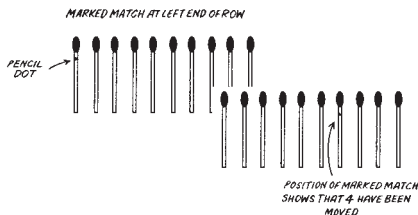

Baffling Bands

Effect: Three loops of paper are cut with surprising results.

Secret: You need three strips of paper, each about five centimetres by one metre. Glue the ends of the first strip together to form a loop. Do the same with the second strip but give one end a half turn before gluing the ends. In making the third loop give the paper one complete turn before gluing.

Cut down the centre of the first loop with a pair of scissors. This will make two loops as one would expect. When the second loop is cut in the same way it forms one extra large loop and the third one produces two loops linked together.

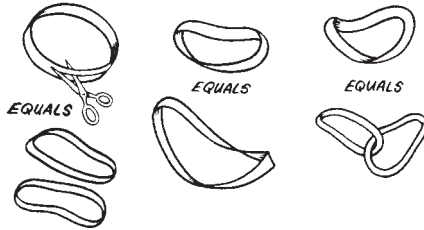

Jumping Elastic

Effect: An elastic band penetrates the fingers.

Secret: Place an elastic band over the first two fingers of your left hand as shown. With the right hand stretch the band to show it really is over the fingers. Close the left hand, at the same time secretly allowing the tips of all your left fingers to go into the band as shown in the second drawing. Open your hand and the elastic band will jump from the first two fingers to the third and fourth fingers. Keep the back of your left hand towards your audience at all times when performing this trick and it will look like the band penetrates through the first two fingers.



Walking Through A Postcard

Effect: A postcard is cut so it will go over your body.

Secret: Boast that you can walk through a postcard then make the following moves. Fold the postcard in half lengthways. Make as many cuts as possible from the edge of the card to the centre and from the centre towards the edges as shown. The more cuts you make the easier the trick is to do. Unfold the card and cut along the centre, from A to B. You can now open out the card into a large loop that will easily go over your body.

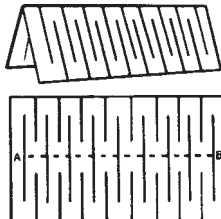

Sympathetic Diamond

Effect: A large Ace of Diamonds changes colour when coloured handkerchiefs are passed over it.

Secret: The principal diamond on the card is actually cut out. It gets its colour from a piece of card held behind the Ace. Each time you want the colour of the diamond to change the secret card is moved to a new position. To get a multi-coloured diamond, position the card centrally so all four corners on the card are visible through the diamond-shaped hole. The handkerchiefs hide the movement of the secret card, look colourful and provide a reason for the colour changes.

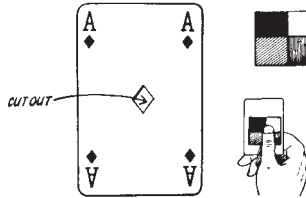

Matchless Ribbon

Effect: Matches change into a ribbon

Secret: Glue together several half matches and put the finished block into the drawer of a matchbox, together with one ordinary match. Put a ribbon in the other end of the drawer. You push open the drawer, take out the single match and let everyone see the box is apparently full of matches. Tap the box with the match you have just removed. Open the box again (but this time from the other end) and show that the matches have changed into a ribbon.

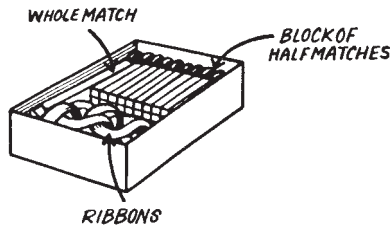

That's It

Effect: You apparently read someone's mind to identify an object selected while you are out of the room.

Secret: You need a secret assistant. While you are out of the room someone selects any object in the room. When you return, your accomplice points to objects around the room but you have arranged that the fifth object he points to will be the chosen object. Identifying objects three times in succession (after arranging a different code number with your accomplice for each repeat performance) should be enough to convince the spectators that you possess amazing powers of mind reading.

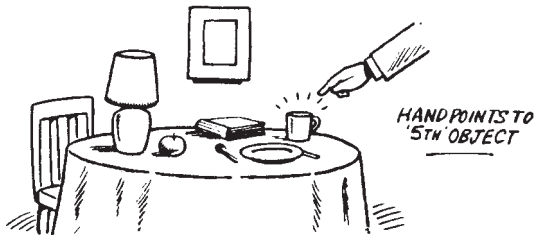

Wallet Of Wonders

Effect: A 10p coin changes to two 5p coins.

Secret: To make the special wallet required you need two sheets of paper, folded as shown. Open out the folds and glue the shaded areas together. Put two 5p coins in the centre of the top sheet and fold it around them. Fold up the bottom sheet and turn the whole lot over. Place a borrowed 10p in the centre of the empty sheet and fold the paper around it. As you do this secretly turn the whole packet over. Open the paper to reveal the two coins.

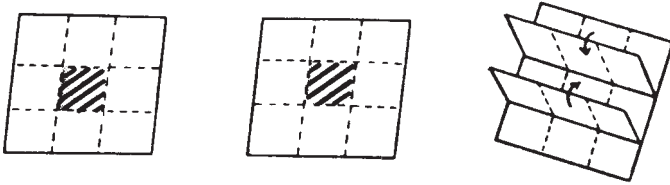

Find The Lady

Effect: A spectator tries to pick the Queen – but ends up with the Joker.

Secret: Glue a piece of a Queen to an Ace. Place a Joker on top and slightly to one side. Put another Ace exactly on top of the Joker. Show the cards (with the Joker hidden). You appear to be holding two Aces and a Queen. Turn the cards face down, as you do so spread them to separate the Joker and the Ace. Invite someone to take the Queen. He will take the centre card – but it is the Joker!



HALF CARD
GLUED ON

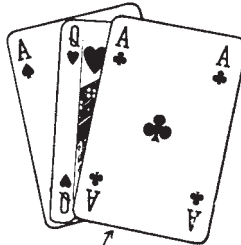

JOKER HIDDEN BEHIND
ACE OF CLUBS

Link Up

Effect: Two paper clips link together without you touching them.

Secret: You need two paper clips and a sheet of paper. Fold over one-third of the paper and place a clip over the top of the doubled thickness. Fold the other end of the paper in the opposite direction to the first and place the second clip over the two thicknesses of paper just formed. The position should now be as shown. Pull sharply on each end of the paper and the clips will leap off into the air and link themselves together.

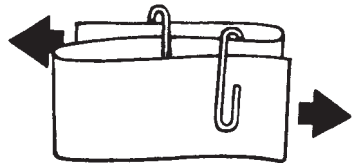

Numbered Thoughts

Effect: While you are out of the room a three-figure number is chosen. On your return, you read your assistant's mind and reveal the number.

Secret: When you return to the room after a number has been chosen, you place your hands on either side of your assistant's head. Your friend now tightens and loosens his jaw for the appropriate number of times to signal each number in turn, pausing between numbers. As your fingers are near his temples you can feel this muscular movement so it is easy for him to transmit numbers to you without saying a word.



Pin-through Pin

Effect: You separate two linked safety pins without opening them – proof that solid can penetrate solid.

Secret: Link two large safety pins together. Hold them as shown. Pull them apart with a sharp downward movement on the right hand pin. There is a knack to getting this movement exactly right but with practice you will be able to do it every time – and the pins will separate. What actually happens is that the pin on the right opens the left pin for a moment. The left pin closes again and it appears that you have caused metal to penetrate metal.

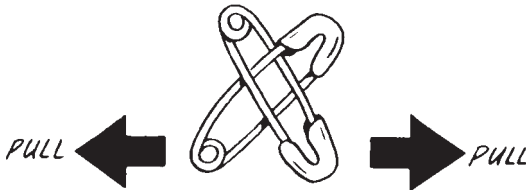

An Expensive Roll

Effect: A bread roll is broken open and a coin is found inside.

Secret: Hold a coin on the fingers of your right hand. The audience must not know this, so keep it hidden. When you are at the dinner table take a bread roll and place it directly on top of the concealed coin. Bend the roll downwards between your hands. This causes an opening in the bottom of the roll. Force the coin into this opening. Now break the roll from the top. As the roll breaks, the coin appears from the middle of the roll.

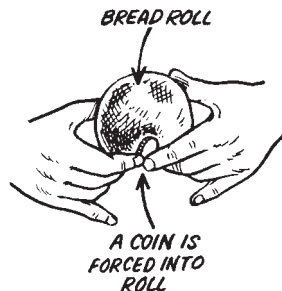

Travelling Ace

Effect: The Ace of Diamonds vanishes from the pack.

Secret: Put the Ace of Diamonds in your pocket. Arrange the remaining Aces so the Ace of Hearts is behind the other two. With the point of the Heart uppermost it looks like the Ace of Diamonds. Turn the cards face down as you say: "I will put these Aces in the pack – the Ace of Clubs, the Ace of Diamonds and the Ace of Spades". Ask a spectator to go through the cards and take out the Ace of Diamonds. When he fails to find it, you take it from your pocket.

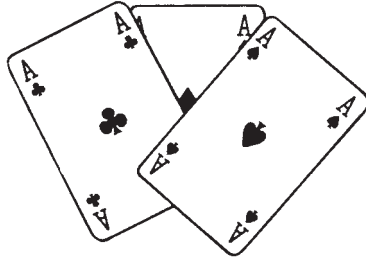

Flag Of The Realm

Effect: Red, white and blue ribbons change into a Union Jack.

Secret: Fold a Union Jack and place it on a sheet of newspaper. Put another sheet of newspaper on top and glue the two sheets together with the flag hidden between them. The prepared newspaper is on your table at the start of the trick. Show some red, white and blue ribbons. Wrap them up in the newspaper. Tear into the newspaper bundle and pull out the flag. Leave the ribbons hidden in the paper.

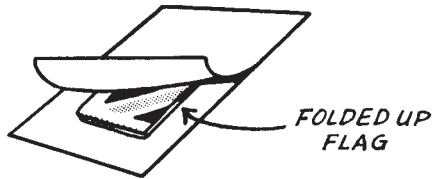

Dictionary Deception

Effect: You read someone's mind.

Secret: On the top right corner of each right hand page of the middle third of a dictionary write the word printed at the top of the left page. Hold the spine of the book in your left hand and ruffle the pages with the right. Ask someone to stop you anywhere. Make certain he stops you somewhere in the central section. Open the book wide and ask him to remember the word at the top of the left hand page. You look at the word you wrote on the opposite page then pretend to read the spectator's mind.



Turn Over Card

Effect: A chosen card reverses itself in the pack.

Secret: Spread the cards face down and ask a spectator to take any card. While he is showing the card to the rest of the audience, secretly reverse the bottom card then turn the whole pack over in your hands.

Walk towards the spectator and ask him to replace his card in the pack face down. As you walk back to your table, turn the reversed card face up and turn over the whole pack again. All the cards are now face down with the exception of one card – the one the spectator chose.

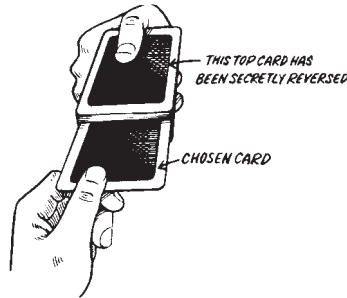

Perplexing Pencil

Effect: A pencil adheres to one hand and then to the other.

Secret: The secret is a small pin pushed into the pencil. Hold the pin between the fingers of your right hand. The pencil seems to stick to the fingers. Bring your left hand to the pencil. Turn to the left and revolve the pencil between your hands. This causes the pin to move from your right fingers to your left fingers. Remove your right hand and the pencil is now apparently stuck to the left fingers. By reversing this movement, you can move the pencil back to the right hand.

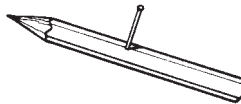

Making Money

Effect: Three coins are placed in your hand. When you open your hand again the number of coins has increased to five.

Secret: Before your performance secretly stick two coins to the underside of your table with Plasticine. Place three coins on the table. Let everyone see that your hands are empty. With your right hand, scoop the coins from the table into your left hand. At the same time, the left fingers reach under the table and take the two hidden coins. Open your left hand and the coins have magically multiplied.

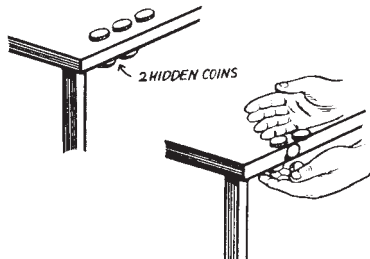

Royal Flush

Effect: Five cards change into a Royal Flush.

Secret: Take the Ten, Jack, Queen and King of one suit and cut them in half diagonally. One half is glued on to one of four other cards of any value and suit. Add an Ace to the group and fan out the cards. It looks like five ordinary cards. Lift the cards so the backs are towards the audience. Take off the Ace and show it, as you secretly turn the other cards end for end. Replace the Ace and then let everyone see the faces. They have changed into a Royal Flush.

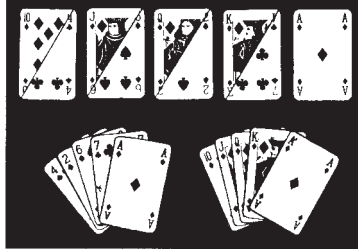

Cut And Restored Ribbon

Effect: A ribbon is cut in two then restored.

Secret: You need a piece of ribbon a metre long and another eight centimetres long. Sew the short piece to the middle of the long piece. Provided you keep it moving, the short piece will not be noticed. Fold the ribbon in half and pull the centre up through your fist. In fact you pull up only the short piece. Cut through the short piece and then cut away the rest of it (including the stitched bit). You have cut the ribbon in two but you can now show it completely restored!

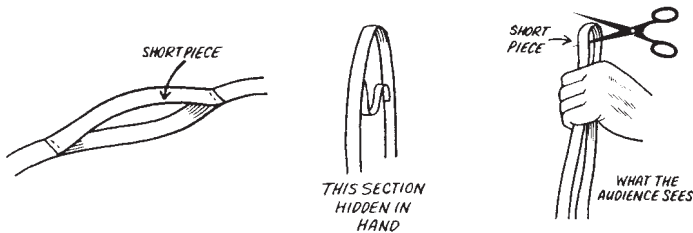

Money Making Matchbox

Effect: Two coins are placed in a matchbox and the box is closed. When the box is opened again the number of coins in it has increased to three.

Secret: Open the matchbox and hide a coin between the top of the drawer and the cover of the box as shown. Place two coins in the box and push the drawer shut. This forces the hidden coin to drop into the drawer. Make a few mystical passes over the box and then open it. Say: "That's the way a magician makes money!".

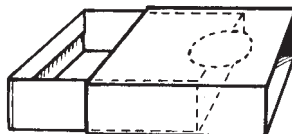

Card Off

Effect: A card escapes from a string.

Secret: A card and an envelope have a hole in their centre. The envelope is secretly prepared with a slit at the bottom. Put the card in the envelope but secretly push it part way out of the slit. This is hidden by your hands. Seal the envelope. Push the string through the hole. Secretly push the card back into the envelope. Ask two spectators to each hold one end of the string. Cut the bottom off the envelope and pull out the card. It seems that the card has penetrated the string by magic.

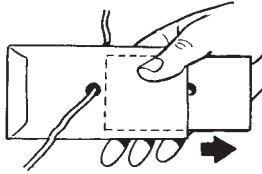

An Impossible Escape

Effect: A handkerchief escapes from a sealed tumbler.

Secret: A coloured handkerchief is placed in a tumbler. It has a fine thread attached to one corner which hangs over the outside of the glass. A second handkerchief is placed on top of the first. Another handkerchief is placed over the glass and secured with an elastic band. Reach under the handkerchief covering the glass and pull the secret thread, pulling the coloured handkerchief from the glass into your hand. Pull it into full view then remove the elastic band and covering handkerchief to prove that the coloured handkerchief really did escape.

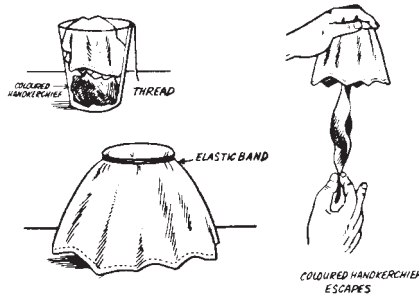

The Mystic Seven

Effect: You predict which pile of cards a spectator will choose.

Secret: On a piece of paper, you write: "You will choose the Seven pile". The paper is then folded and given to a spectator for safekeeping. You now take several cards from a pack and arrange them in three face-down piles. The three piles are formed as follows: Pile One: Any seven cards. Pile Two: The four Sevens. Pile Three: An Ace, a Two and a Four (which add up to seven). A spectator is given the choice of any of the three piles. Whichever pile is chosen the prediction is always correct.

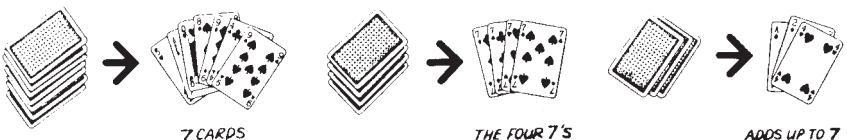

Sweet And Sour

Effect: You tell the difference between sweet and sour by means of an amazing mental ability.

Secret: On a sheet of card write the words "SWEET" and "SOUR" and tear the card into nine pieces as shown. The pieces are dropped into a bag and mixed up. When you reach in and take a card, you know immediately whether the word on it is "SWEET" or "SOUR". This is possible from the way the card is torn. The "SOUR" pieces have only one straight edge. The "SWEET" pieces have two straight edges, with one exception which has no straight edges whatsoever.

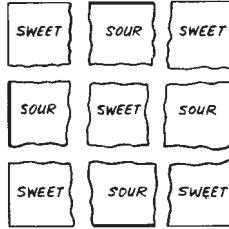

Magic Stamp Album

Effect: An empty album becomes magically filled with stamps.

Secret: You need an exercise book to make this trick. Go through the book and cut a narrow strip from the edges of every other page. On every double page where the short edge is to the right, stick some stamps. The pages where the short page is on the left should be left untouched. Flick through the pages with your right hand and it will look like an ordinary exercise book. Say some magic words and flick through the book again using your left hand and the book is filled with stamps.

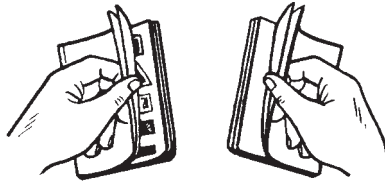

Red Or Black?

Effect: From a pack of cards spread face down on a table, you are able to tell which are red cards and which are black.

Secret: First separate the reds from the blacks. Bend all the red cards upwards. Bend all the black cards downwards. Mix the cards together. Spread all the cards face down on your table. Throw them down haphazardly and then invite a spectator to mix them up even more, so it is obvious they are not in any special order. Ask people to point to different cards and you can tell them if they are red or black by the way they bend.



BLACK CARDS



RED CARDS

Homing Coins

Effect: Four coins disappear then magically return.

Secret: On two sides of a triangular stand is a ledge to hold four coins. Those on one side are loose, the others are glued in place. The stand is on your table with the loose coins on show. Pretend to take the first coin away but really let it fall behind the stand. Put the imaginary coin in a paper bag. Do the same with the other coins. As you cover the stand with a scarf, tip the stand backwards. Blow up the bag and burst it. Whisk the scarf away and the coins have returned.

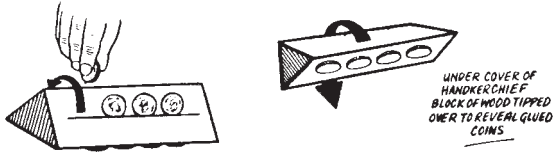

Change The Ace

Effect: The Ace of Spades changes to the Ace of Hearts.

Secret: Place the Ace of Hearts and the Ace of Spades on top of the pack. Turn over the top card and show it is the Ace of Spades. Place it back on the pack face up. Push the two top cards a little to the right, so they overlap the edge of the pack by one centimetre. Throw the pack firmly down on the table. Air pressure causes the two top cards to turn over and the Ace of Hearts will now be face up.

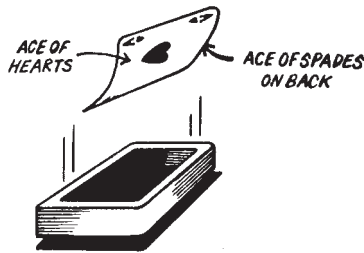

Marvellous Memory

Effect: You appear to memorise the order of a pack of cards.

Secret: Cut a small hole in the bottom right corner of your card case.

Ask someone to shuffle the cards and hand them back to you. Look through the cards quickly, then place them in the case. Hold the case in front of you and you will see the index of the first card through the hole. Name this card and pull it from the case. Do the same with a few more until you think you have proved that you really did memorise the order of the cards.



Indestructible Handkerchief

Effect: A large safety pin is pulled through a handkerchief without tearing it.

Secret: Ask someone to hold a handkerchief out taut. Push a safety pin through the material, near the edge of the handkerchief. Hold the pin by the tail end and turn it towards yourself. Now pull the pin to the right. When you stop, push the pin forward so it goes back through the material. You have moved the pin from one place to another without tearing the handkerchief. What actually happens is that the material runs between the bar and the head of the pin.

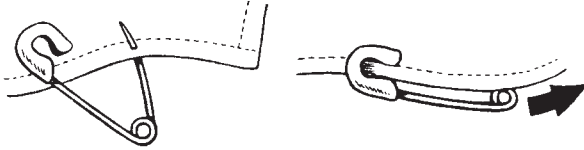

That's Torn It!

Effect: A coin is wrapped in paper. You then tear up the paper – the coin has disappeared!

Secret: Place the coin on the paper, just above the centre. Fold the top portion of paper down over the coin.

Fold the right side of the paper around to the back. Do the same with the left side.

Lastly, fold the bottom portion back. This procedure leaves the bottom edge of the packet open. Hold the paper in your hand and allow the coin to slip secretly into your hand. Tear up the paper and the coin seems to have vanished.

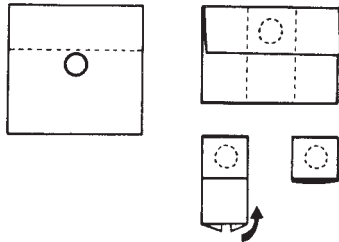

A Capital Prediction

Effect: A capital city is chosen. Inside an envelope which has been on full view is a paper naming the city selected.

Secret: Write a capital city on a piece of paper and seal it in an envelope.

Capital cities are called and you write them down on slips of paper which are folded and dropped into a box.

In fact you write the same name on every slip – the name of the city in the sealed envelope.

Someone picks a slip and calls out the chosen city. The envelope is opened to show you knew which city would be chosen.

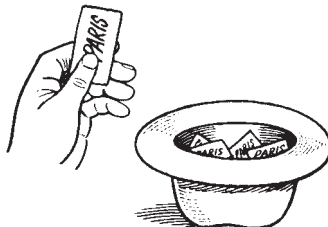

Calculated Discovery

Effect: You remove cards from your pocket to the value of a chosen card.

Secret: Put the Ace of Clubs, Two of Hearts, Four of Spades and Eight of Diamonds in your pocket. Have the pack shuffled then put it in your pocket.

Ask someone to name a card. The four cards you hid can represent any card. For the Six of Clubs you take out the Four and the Two to make six and the Ace to show Clubs. For the Queen of Diamonds take the Eight and the Four to make 12 and point to the Eight of Diamonds and so on.

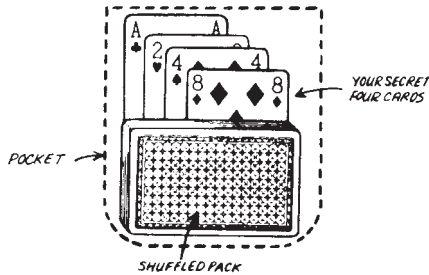

Ring Of Deception

Effect: A bangle passes on to a length of rope tied securely to your wrists.

Secret: You need two identical bangles and a long piece of soft rope.

Secretly put one of the bangles on your arm, hidden under your coat sleeves. Have two spectators tie each end of the rope around your wrists. Show the bangle to ensure that it is solid. Turn your back, quickly pull the secret bangle down your sleeve on to the rope and hide the bangle just shown in an inside pocket. Turn back to face the audience and show the bangle tied on the rope.

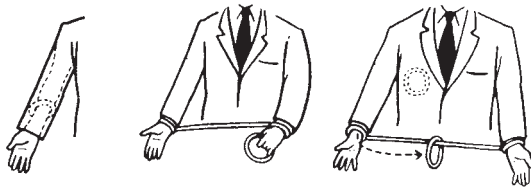

Match Maker

Effect: Matches appear in an empty box.

Secret: The matchbox drawer is secretly prepared by cutting it in two. One section is longer than the other. Put the two pieces of drawer in the box and fill it with matches. To show the box empty pull the long part of the divided drawer from the box. The matches will remain in position inside the cover and the drawer will appear to be empty. Close the drawer. To show the box full push the drawer from the other end. This moves both pieces of the drawer and the matches make their appearance.

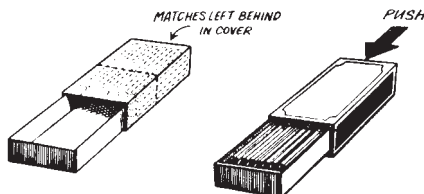

The Self-propelled Ball.

Effect: A ball rolls across the table until you tell it to stop.

Secret: Under the table cloth is a small ring attached to a length of strong thread. The thread runs across the table to where your secret assistant is sitting. A small ball is placed on the table. It must go into the concealed ring. On your word of command your assistant pulls on the thread and the ball moves. You then pick up the ball and hand it to a spectator. As you are doing this, your assistant pulls the ring from beneath the cloth and hides it.

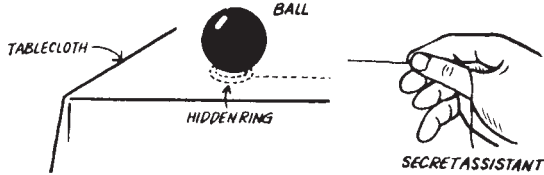

Disappearing Coin

Effect: A coin disappears from your hand in spite of the fact that several people check it is there.

Secret: Show the coin on the palm of your hand and cover it with a handkerchief. Go to several people and ask them to feel the coin under the handkerchief. The last person you approach is (unbeknown to the rest of the audience) your secret assistant. He pretends to feel the coin but actually takes it off your palm. You can now pull the handkerchief away with a flourish and your hands are shown completely empty. The coin has disappeared.

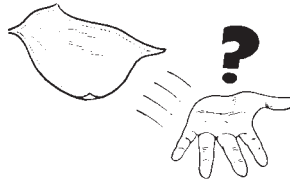

Fruit Transformation

Effect: An orange transforms itself into an apple.

Secret: Carefully cut the peel from an orange, as shown in the illustration and scoop out all the fruit. When the peel has dried put an apple inside it. Hold the peel closed and it appears you are holding an ordinary orange. Cover the orange with a handkerchief. When you remove the handkerchief, take the orange peel off the apple but keep it hidden within the material. Casually drop the handkerchief (with the orange peel still hidden) behind something on your table or put it in your pocket, as you display the apple.

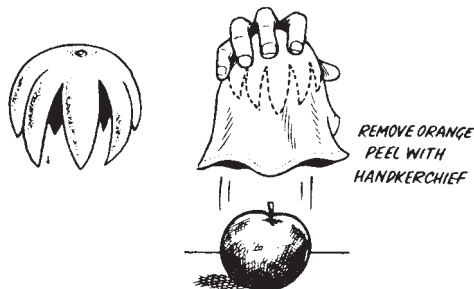

In The Red

Effect: You instantly identify a selected card.

Secret: Place all the black cards on top of the red cards and you are ready. Spread the cards face down and ask someone to take any card. Make sure he takes one from the top (black) half of the pack. He then replaces it anywhere in the pack but you make sure he replaces it somewhere in the bottom (red) half of the pack. Look through the cards and somewhere in the red cards will be one black card. That is the chosen card. Remove it and show it to everyone.

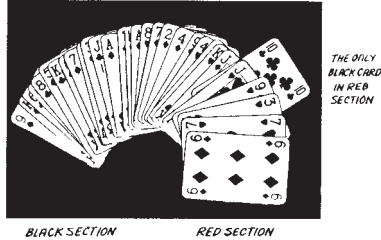

Going Up!

Effect: Two tumblers are suspended from a newspaper balanced on a magic wand.

Secret: Bend a paper clip around your magic wand to form a U shape. Tape the wire to a newspaper. The newspaper is shown and then folded into a long flat tube. Place the newspaper across two tumblers, making sure that each prong of the wire goes into the tumblers. Place your wand between the tumblers and lift it towards the newspapers. The newspaper will be lifted – but so will the tumblers.

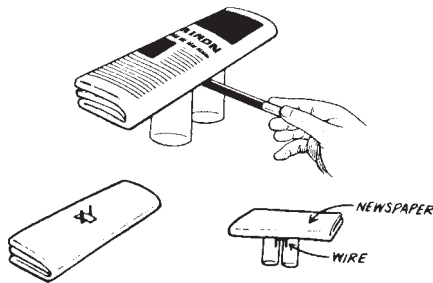

Name That Name

Effect: You reveal a thought-of name.

Secret: Cut a slot in the top of a box with a removable lid and tape a small box on the inside. Write the same name on 10 slips of paper. Put them in the box and replace the lid. Hand out 10 blank slips and ask spectators to write a name on their slip. The slips are put in the box through the slit. They actually go into the hidden box. Remove the lid for just one slip to be chosen. As all the slips are the same it is easy to reveal the name chosen.

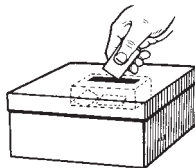

The Ninth Card

Effect: You divine the identity of a selected card.

Secret: This is how to make someone take the card you want. Secretly place the card you decide to use ninth from the top of the pack. Ask someone to call a number between 10 and 20. Count that number of cards, one at a time, from the pack. Add the digits of the chosen number. Deal that number of cards off the cards just dealt. Ask someone to look at the next card. It will be the card you placed at ninth position.

You can reveal it in any way you wish.



Indestructible String

Effect: A string is threaded through a drinking straw. The straw is cut in two but the string remains unharmed.

Secret: Secretly cut a short slit in the straw. Thread the string through the straw. Bend the straw in half and pull both ends of the string. This forces the string through the slit in the straw. Your hand hides this from the audience. Cut through the straw, as shown by the dotted line in the drawing. Now pull the string from your hand. The straw is in two pieces but the string is still whole.

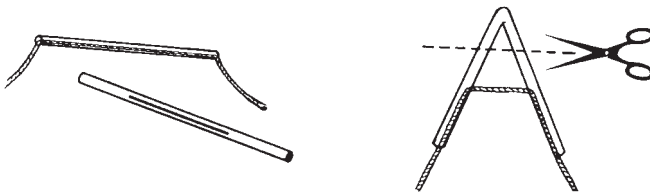

Multiplying Money

Effect: Three coins increase to six in your hand.

Secret: Show three coins and count them out on to a magazine. Unbeknown to your audience there are three more coins hidden inside the magazine cover. Fold the magazine slightly and tip the three visible coins into your hand. At the same time the three hidden coins will slip from the magazine into your hand too but the audience do not know about this. Wave your other hand over the one holding the coins. Slowly open your hand to show that the coins have mysteriously multiplied.

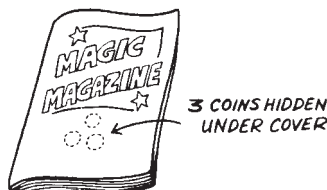

Money Telepathy

Effect: While you are out of the room, a coin is hidden under a cup. When you return, you announce the value of the hidden coin.

Secret: A secret accomplice is used. It is your accomplice who actually places the cup over the coin. He places the cup down in such a way that the position of the handle tells you the value of the hidden coin as shown in the illustration. Before doing this trick, you must agree with your accomplice which handle position will be at the 12 o'clock position or you may read the signal upside down and that could prove disastrous! This trick can of course be performed using any currency.

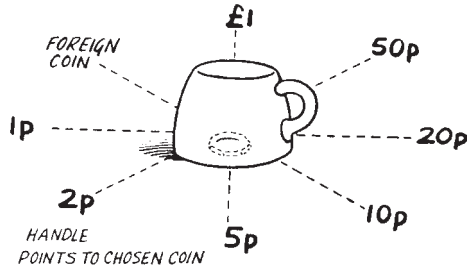

Card Code

Effect: You identify a chosen card.

Secret: Place nine cards on the table. The suits do not matter but the values must be the Ace to the Nine. While you are out of the room, someone chooses any one of the nine cards. When you return, you know immediately which card has been chosen because you have a secret assistant who holds a pack with a Nine showing. They secretly indicate the value of the chosen card to you by the position of their thumb over one of the nine pips.

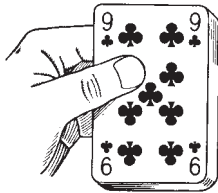

Match Rise

Effect: A match rises from a matchbox.

Secret: Make a small hole in the top of a matchbox. Push a match into the hole as shown in the illustration. When you push the drawer, the match will be forced out through the hole. If you tilt the matchbox slightly with the end of the drawer facing the audience, it will give the impression that the match rises from the drawer as it is opened.

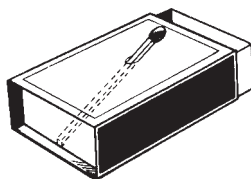

The Ghostly Card

Effect: A playing card vanishes when placed in a glass tumbler.

Secret: You need a piece of clear plastic the same shape and size as a playing card. Place this on top of a pack of cards. Cover the cards with a handkerchief and apparently remove the top card in the handkerchief. You actually take the sheet of plastic. Show a glass tumbler and ask a spectator to push the card, still covered by the handkerchief, into it. Whisk the handkerchief away and the card has vanished. Being transparent, the plastic cannot be seen from even a short distance away.



Watch Wizardry

Effect: You use a watch to divine a thought-of-number.

Secret: Show a watch and ask someone to think of any number from 1 to 12. Tap a pencil against numbers on the dial. As you do this, the spectator mentally counts to 20, one for each tap, beginning with one above the number he is thinking of. You make the first seven taps anywhere on the watch face. On the eighth, tap your pencil on 12. Continue tapping the numbers anti-clockwise around the dial. When the spectator reaches 20, your pencil will be pointing to the number he is thinking of.



Floating Ball

Effect: A small ball defies gravity and floats in space

Secret: The secret is a long loop of dark thread which is on your table with a ping-pong ball resting on it. Put your thumbs through each end of the loop. Lift your hands with the thread stretched between them and the ball appears to be floating in the air. With practice you can make the ball float from hand to hand (it is really just rolling along the thread). You must wear dark clothing for this trick and be a little distance from your audience so the thread cannot be seen.

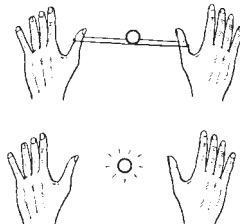

Changing Card

Effect: A playing card changes value magically.

Secret: You need an Ace of Clubs, a Queen of Hearts and one other card.

Score across the centre of the Ace and the Queen and glue them together for half their length. Use the third to form a back to the special card. Hold the card in your left hand with the flap pointing upwards. Pass your right hand over the card and, as you do so, push the flap down to its lower position – and the card changes.

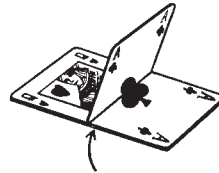

THIRD CARD
GLUED (TO FORM BACK)

Chain Reaction

Effect: Paper clips form themselves into a chain.

Secret: Link 10 paper clips and put them in one corner of an envelope. Put a strip of glue on the inside of the envelope, just above the chain. Put 10 loose paper clips into the envelope and you are ready to show the trick. Tip out the loose clips then drop them, one at a time, back into the envelope and seal it down. Tear off the corner of the envelope. The chain will drop out. Casually put the envelope in your pocket and display the chain of clips.

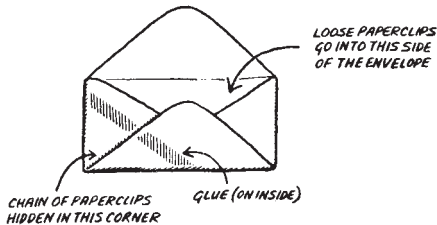

Your Card Is ...

Effect: You tell a spectator the name of a card he chose.

Secret: Spread a shuffled pack face up to show they are well mixed. Remember the bottom card. Turn the cards over and ask a spectator to take one. Ask him to remember the card and then place it face down on top of the pack. Cut the cards a few times. Spread the cards before you. The selected card is the next card to the right of the one you remembered earlier. Pretend to read the spectator's mind and reveal the card selected.

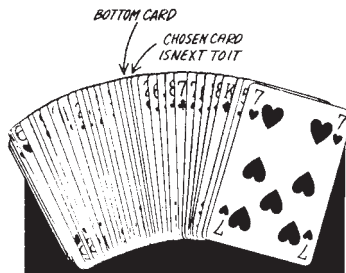

Salt Cellar Suspension

Effect: A salt cellar is suspended from your fingertip.

Secret: All you need, apart from the salt cellar, is a toothpick. Keep the toothpick hidden behind your forefinger as you touch the salt cellar. Secretly push the toothpick into the top of the salt cellar. Hold the hidden toothpick between your thumb and forefinger and you can lift the cellar. It appears that the cellar is sticking to your finger. Take the cellar in your left hand and pull it away from the toothpick. As you hand the cellar to someone for examination, secretly drop the toothpick on your lap.

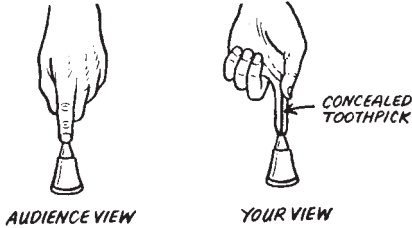

Crafty Catch

Effect: Two pre-determined cards are caught in mid-air.

Secret: Secretly place the Seven of Clubs on the bottom of the pack and the Nine of Spades on the top.

When you do the trick, remove the Seven of Spades and the Nine of Clubs from the pack. Show them briefly and push them into the pack. Throw the pack in the air but keep tight hold of the top and bottom cards.

Pretend you have caught the two you now hold. Show them triumphantly and everyone will believe they are the two cards you placed in the centre of the pack earlier.

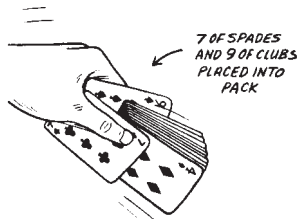

Quick Tie Handkerchiefs

Effect: Two handkerchiefs are thrown in the air where they knot themselves together.

Secret: Apart from the two handkerchiefs, all you need for this trick is a small elastic band hidden in your right hand. Pick up one of the handkerchiefs with your left hand and place it in the right. As you do so, push a corner of the handkerchief into the elastic band. Do exactly the same with the second handkerchief. Throw the two handkerchiefs into the air and catch one of them as they descend. The elastic band holds the two handkerchiefs together and they appear to be knotted.

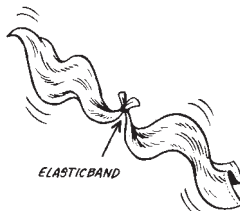

Sum Trick!

Effect: You predict the total of a sum.

Secret: Write 1089 on a piece of paper, fold it and place it on your table. Ask someone to choose any three-digit number. All three digits must be different and the first must be higher than the last. Get them to reverse the whole number and write that underneath the first. If, for example, he chose 983 he now writes 389. The lower number is then subtracted from the other. The answer (which, in this example, is 594) is then reversed and this time the two are added together. Open the paper – your prediction is the same as the spectator's total. In fact, if the calculations are done correctly, the answer is always 1089!

983	← ANY NUMBER
- 389	← REVERSED
= 594	← SUBTRACTED TOTAL
+ 495	← REVERSED
= 1089	← ADDED TOTAL

- THE TOTAL MATCHES YOUR PREDICTION!

Rope Through Body

Effect: A rope passes through your assistant's body.

Secret: Two spectators are invited to examine a long length of soft rope. Put the middle of the rope over your assistant's head to her front. Take both ends of the rope around the back of her body where you apparently cross over the ends. In fact your assistant secretly sticks up her thumbs and you wrap the rope around them as shown. Hand the ends of the rope to the spectators on either side. When you clap your hands your assistant secretly lowers her thumbs and walks forward – free of the rope.

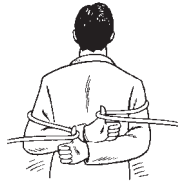

Soapy Secret

Effect: A coin is shown on the palm of the left hand. A moment later the coin has vanished.

Secret: This trick only works with a small coin. The coin is shown on the palm of your left hand which is then closed into a fist. You then press the nail of your second finger against the coin, for on that nail is a small piece of soap. When you open your hand it seems that the coin has disappeared – but it is really stuck to the back of the second finger with the soap.

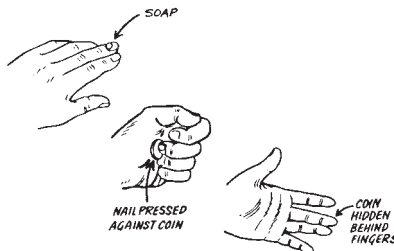

Sweets To The Sweet

Effect: Sweets, produced from a handkerchief, eventually vanish.

Secret: Tie a wrapped sweet to a long length of thread. Attach the other end of the thread to the centre of one side of a handkerchief. Fold the handkerchief in half. Hold two corners in one hand and two in the other. Tip the handkerchief and the sweet falls out into a box on your table. Allow the handkerchief to fall open, with the sweet hidden at the rear. Lift the handkerchief and repeat the above movements until you have produced numerous sweets. Then tip the box to show they have vanished.

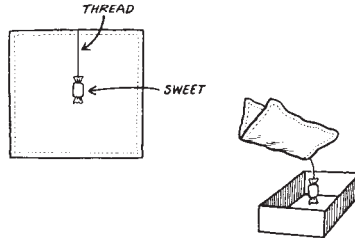

Spotted

Effect: You predict the numbers on two dice.

Secret: On a postcard write the numbers four and five. Place the card in an envelope. Glue two dice in one end of the drawer of a large matchbox with the four and five spots uppermost. Put two loose dice in the other end of the drawer. Open the matchbox to show the loose dice. Close the drawer and ask a spectator to shake the box. Take the box back and open the drawer at the end containing the glued dice. Allow someone to see the dice then close the drawer. Your prediction is opened and it, of course, correct.

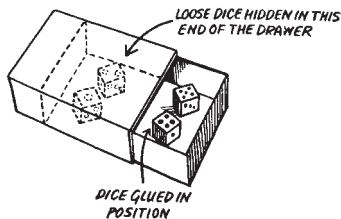

That Rings A Bell

Effect: A small bell rings of its own accord.

Secret: A small bell is on your table. Hold an opaque scarf in front of you, between your hands. In the top right corner of the scarf there is a small pin. Show the other side of the scarf by moving the right hand to the left and the left hand to the right. Do this a few times, then pin the scarf to your left shoulder. This leaves your right hand free to reach down and ring the bell. Immediately bring your hand back up to recover the scarf from your shoulder.



Clip The Card

Effect: A spectator tries to put a paper clip on the centre of a group of five cards but fails.

Secret: Glue five playing cards together. The card in the centre should stand out from the rest. Show the cards to a spectator. Hand him the clip and ask him to put it on the centre card when you have turned the cards face down. He puts the clip on the centre card. When you turn the cards face up the clip is actually on the end card! The trick works by itself – but there is no need to tell your audience that!

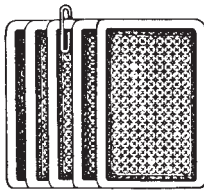

5 CARDS GLUED TOGETHER

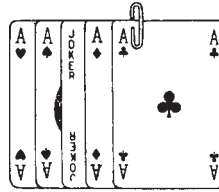

The Travelling Coin

Effect: A coin travels from one hand to the other.

Secret: Place a coin on the palm of your left hand and another on the fingers of your right hand as shown. Turn over hands quickly and simultaneously. Lift the right hand and the coin has vanished. Lift the left hand to reveal there are two coins beneath it. Due to the positioning of the coins, this trick works automatically. Even so, you should still practise it in private before showing it to anyone. If you are left handed, you may find that the trick works better if the positions of the coins are reversed.

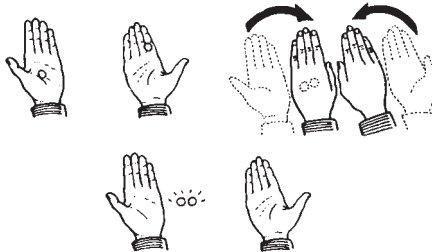

Food And Drink

Effect: From cards bearing the names of foods, you pick out the odd card on which is written the name of a drink.

Secret: You need six blank cards, one of which is fractionally longer than the others. Hand five cards to spectators and ask them to write down foods. The long card is handed to someone with the request that he write the name of a drink. The cards are mixed up and handed back to you. Without looking you immediately pick out the drink card. You can detect it quite easily by touch.

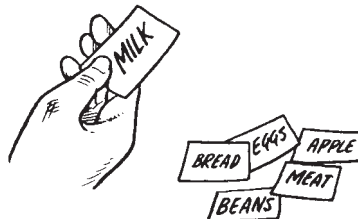

Aces Discovery

Effect: You hold a shuffled pack behind your back and locate the four Aces

Secret: Secretly remove the Aces from the pack. Push them into a paper clip which is pinned to the inside of your coat at the rear. When you want to show the trick, hand the pack to someone to be shuffled. When the cards are returned to you, hold them behind your back and say you are about to attempt the impossible. Secretly remove the Aces from the hidden clip and bring them forward one at a time as if you have searched through the pack for them.

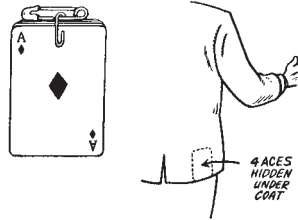

Unburstable Balloon

Effect: You stick pins into an inflated balloon – but, thanks to your magical powers, the balloon does not burst.

Secret: The balloon has on it several pieces of clear adhesive tape. These will not be visible from even a short distance away. Push a pin into the balloon at one of the taped areas and the balloon will not burst (although it will go down after a while). You can push the pin into several different places to prove your magical ability. When you want the balloon to burst simply push the pin into an area that is not protected by tape.



Spin Vanish

Effect: A matchbox is banged on a spinning coin to stop it. When the matchbox is lifted the coin has vanished.

Secret: Spin a small coin on the table top. Hold the matchbox, which must be empty, so that the drawer is open side down. Bang the matchbox sharply on top of the coin. Ask a spectator if he thinks the head or tails side of the coin is uppermost. Lift the box and the coin has disappeared. Because you banged the matchbox down so hard the coin penetrated the cover and is now inside the box.

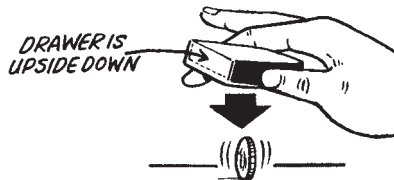

Money, Money, Money

Effect: Spectators try to win some money – but you win.

Secret: You show five envelopes. One contains a £5 note, the others slips of paper. You have secretly marked the money envelope with a pencil dot. Ask someone to mix the envelopes then return them to you. Move the marked envelope to the second position. Ask someone to spell "money", transferring one envelope to the bottom of the pile for each letter. He keeps the envelope that falls on the letter Y. Do the same with three other spectators. You are left with one envelope, the one containing the money.

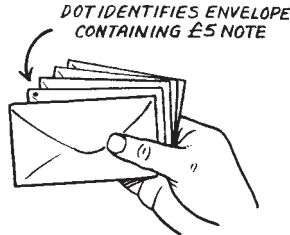

Where Are The Matches?

Effect: Two empty matchboxes and one containing some matches are moved around on a table.

The spectators are unable to identify which box contains the matches.

Secret: All three matchboxes are empty. Attached to your right arm and hidden by your sleeve is a matchbox containing some matches. Shake a box with your left hand it sounds empty. When you mix up the three visible boxes you can make any one appear to be the full one, simply by shaking it with your right hand. The spectators think it contains matches because they hear the sound from the hidden box.

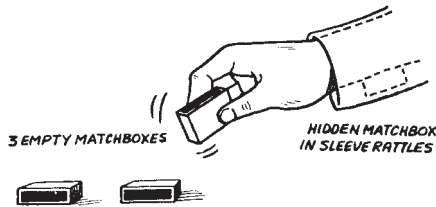

Anti-Gravity Cards

Effect: Several playing cards adhere to your hand, until you tell them to fall off.

Secret: You need to make a special card. It is simply an ordinary card with a tab cut from another card attached to its back. The special card is first placed face up on your palm and the tab is gripped between your fingers. Arrange some more cards between the special card and your hand as shown. Turn your hand over and the cards will appear to be sticking to it – until you let go of the tab.

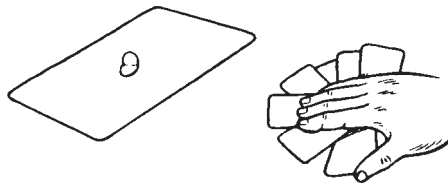

Coin In The Glass

Effect: A coin disappears.

Secret: Put a coin in the centre of a handkerchief draped over your right hand. Place a glass tumbler on the palm of your left hand. Turn your right hand over, retaining a grip on the coin and bring the handkerchief over the glass. When the glass is covered tilt it towards you. Drop the coin. It hits the glass (convincing everyone it has gone into the glasses) and drops onto your hand. Place the glass (still covered) on your table and casually drop the coin in your pocket. Remove the handkerchief – the coin has vanished.



Colour Sense

Effect: You identify the colour of a crayon handed to you behind your back.

Secret: Ask someone to take any crayon from a box and hand it to you behind your back. You then turn to face the audience but keep the crayon behind your back. Secretly dig your right thumb into the crayon. Keep hold of the crayon behind your back as you bring your right hand up to your forehead as if concentrating. Take a quick look at your nail – you will see bits of crayon in it and will know the chosen colour. Concentrate some more and then announce the colour.

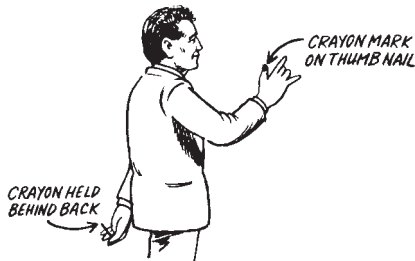

Anti-Gravity Matches

Effect: A box of matches is opened and the drawer held upside down. The matches defy the laws of gravity and do not fall out – until you command them to.

Secret: Wedge a match across the drawer of a box of matches. You will probably have to shorten the match to do this. When you take the drawer from the box, hold it by the sides to keep the secretly-wedged match in position. Command the matches to fall and release the pressure on the wedged match. All the matches fall from the box on your command.

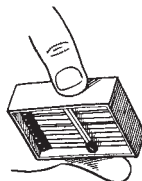

Going By Tube

Effect: A rolled magazine travels up and down a string.

Secret: Roll a magazine into a tube and use paper clips to hold it. Double a piece of string and hook its centre on the bottom clip inside the tube. A second string is looped through the first as in the illustration. Pull on the strings at top and bottom and the magazine will rise up the string. Pull on the top string, relax your grip on the lower string and allow your hands to move slightly closer together and the magazine will go back down.

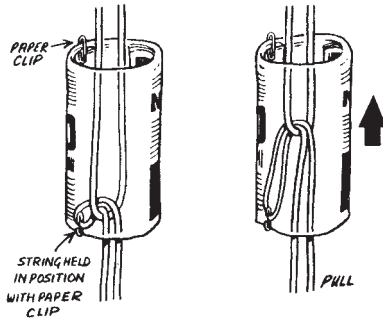

The Haunted Pack

Effect: A pack of cards divides to reveal a chosen card.

Secret: Ask someone to take a card, look at it and remember it. Point to the top card of the pack. As you do this you secretly drop a few grains of salt on the top card. The spectator puts his card on the top of the pack and the pack is then cut, so the chosen card is hidden somewhere near the centre. Hit the edge of the pack with the heel of your hand and, thanks to the secret salt, the pack will divide at the chosen card.

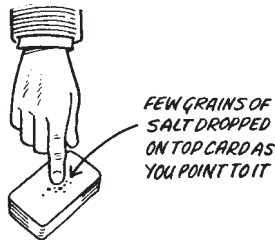

Miserable Money

Effect: When you shout at a coin, it gets so upset it bursts into tears!

Secret: Secretly conceal a wad of wet tissue paper between the first and second fingers of your right hand. Borrow a coin and place it directly on top of the tissue. Be careful that you do not allow anyone to see the tissue as you do this. Now squeeze the coin and the tissue together. Water drips from the tissue and it appears that the coin is crying.

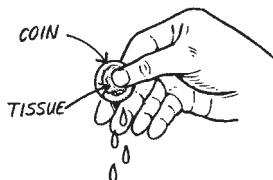

Two In The Hand

Effect: Someone thinks of one of two items, you predict which.

Secret: Give someone any two items. They could be coins, cards, buttons – anything you like. He holds one in one hand and one in the other. While your back is turned, ask him to think of either object – he has a free choice. To help him concentrate suggest he holds the chosen object up to his forehead. After a short while, ask him to lower his hand and you then turn round. You know which he chose as the hand holding it will be lighter than the other. Holding it up causes blood to drain from that hand.

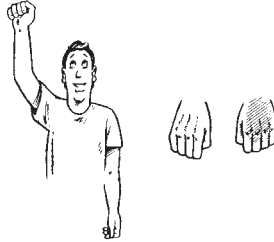

Match Restoration

Effect: A matchstick is broken in half then magically made whole.

Secret: You need a handkerchief with a matchstick hidden in its hem. A match is taken from a matchbox and wrapped in the handkerchief. Ask a spectator to break the match through the material but make sure it is the one hidden in the hem that he breaks. Shake out the handkerchief and the match just removed from the box falls out. Casually put the handkerchief (with the broken match concealed in the hem) back into your pocket. It appears that the match was restored by magic.

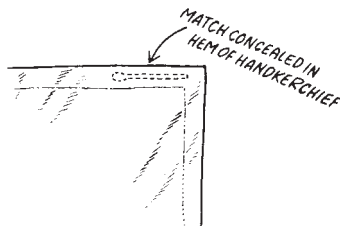

Vanishing Ring

Effect: You make a finger ring vanish.

Secret: The ring is tied to a long piece of elastic which runs up your sleeve to a safety pin attached to the top of the sleeve. The elastic should be long enough to allow you to put the ring on your finger. Take the ring off and pretend to show it in the air. When you let go, the elastic carries the ring up your sleeve. You could, if you wish, find the ring (a duplicate) in a sealed box that has been on your table since the start of the trick.

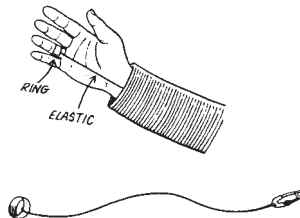

On Your Mark

Effect: A selected card is located within seconds.

Secret: With a soft black pencil draw a diagonal line down both sides of a pack of cards. When you show the trick, you remove the cards from the case and ask someone to take any card, remember it and return it anywhere in the pack. Pick up the pack and look at your pencil mark. At one point there will be a small back mark out of alignment with the rest of the line – that is the chosen card.

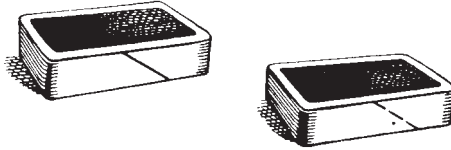

Metal Bending

Effect: A spoon is bent and then straightened again.

Secret: Take the spoon in your left fist. Position the bowl so it rests on the table. Move your right hand over the left and change the left grip to hold the spoon by third and little fingers. As you pretend to press the spoon against the table top, bring your hands up to a vertical position as if really bending the handle. Move the hands back and forth as if the metal is becoming really supple. Blow on the spoon and throw it on the table. The handle is straight.

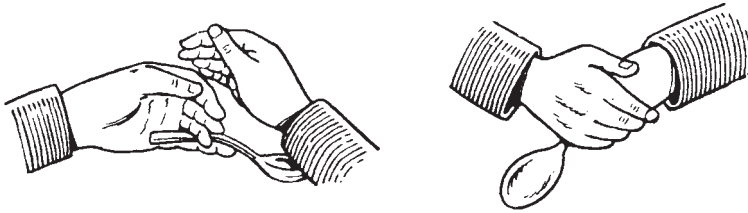

Spirit Initials

Effect: A spectator's initials appear on his own hand.

Secret: Hand someone a soft pencil and ask him to print his initials on a sugar cube. Take the sugar and secretly press your thumb against the initials. Drop the sugar in a glass of water. Ask the spectator to hold his hand over the glass. To show him what to do, you guide his hand over the glass. As you do this, press your thumb against his palm. You have now transferred a copy of the initials to his palm. He will receive a surprise when he sees the initials on his palm.



A Phantom Message

Effect: Someone's name mysteriously appears written on your arm.

Secret: Secretly find out someone's name and write it on the back of your forearm with a piece of soft soap before you perform this effect. This will be invisible to our audience until you rub some cigarette ash or soot over it. At the appropriate moment during your performance, you can dramatically reveal this name!



Beads Of Mystery

Effect: You mend a broken necklace by magic.

Secret: There are two threads in the necklace – one through all the beads and the other through all but one. Tie one knot at the top of the short thread and two knots on the long thread. Show the beads then cut off the bottom bead. The beads slide off the long thread into a glass on your table. It looks as if the beads are all separate. Pretend to drop the loose thread into the glass but secretly keep it in your hand. Make a magic pass and then show the beads magically rethreaded.



**Fellow magicians agree never
to reveal their secrets!**

Index

Cup Through Table	2	Pin Through Pin	14
Wand Power	2	An Expensive Roll	14
Ring And String	3	Travelling Ace	15
Appearing Wand	3	Flag Of The Realm	15
Rubber Wand	3	Dictionary Deception	15
Palm The Wand	4	Turn Over Card	16
Find The Coin	4	Perplexing Pencil	16
Reverse Loops	4	Making Money	16
Sticky Wand	5	Royal Flush	17
Rising Pencil	5	Cut And Restored Ribbon	17
Dice Deception	5	Money Making Matchbox	17
Bewildering Beaker	6	Card Off	18
Ring On	6	An Impossible Escape	18
Floating Beaker	6	The Mystic Seven	18
The Removable Thumb	7	Sweet and Sour	19
Folding Money	7	Magic Stamp Album	19
Stop!	7	Red Or Black?	19
Kings And Aces	8	Homing Coins	20
Spelling Bee	8	Change The Ace	20
A Neat Escape	9	Marvellous Memory	20
Pencil Vanish	9	Indestructible Handkerchief	21
Knot From Nowhere	10	That's Torn It	21
Card To Matchbox	10	A Capital Prediction	21
It's Matchic!	10	Calculated Discovery	22
Baffling Bands	11	Ring Of Deception	22
Jumping Elastic	11	Match Maker	22
Walking Through A Postcard	11	The Self-propelled Ball	23
Sympathetic Diamond	12	Disappearing Coin	23
Matchless Ribbon	12	Fruit Transformation	23
That's It	12	In The Red	24
Wallet Of Wonders	13	Going Up!	24
Find The Lady	13	Name That Name	24
Link Up	13	The Ninth Card	25
Numbered Thoughts	14	Indestructible String	25

Multiplying Money	25	Anti-Gravity Cards	34
Money Telepathy	26	Coin In The Glass	35
Card Code	26	Colour Sense	35
Match Rise	26	Anti-Gravity Matches	35
The Ghostly Card	27	Going By Tube	36
Watch Wizardry	27	The Haunted Pack	36
Floating Ball	27	Miserable Money	36
Changing Card	28	Two In The Hand	37
Chain Reaction	28	Match Restoration	37
Your Card Is...	28	Vanishing Ring	37
Salt Cellar Suspension	29	On Your Mark	38
Crafty Catch	29	Metal Bending	38
Quick Tie Handkerchief	29	Spirit Initials	38
Sum Trick!	30	A Phantom Message	39
Rope Through Body	30	Beads Of Mystery	39
Soapy Secret	30		
Sweets To The Sweet	31		
Spotted	31		
That Rings A Bell	31		
Clip The Card	32		
The Travelling Coin	32		
Food And Drink	32		
Aces Discovery	33		
Unburstable Balloon	33		
Spin Vanish	33		
Money, Money, Money	34		
Where Are The Matches?	34		

Published by Marvin's Magic, London, N17 0SP

